

FIG. 1

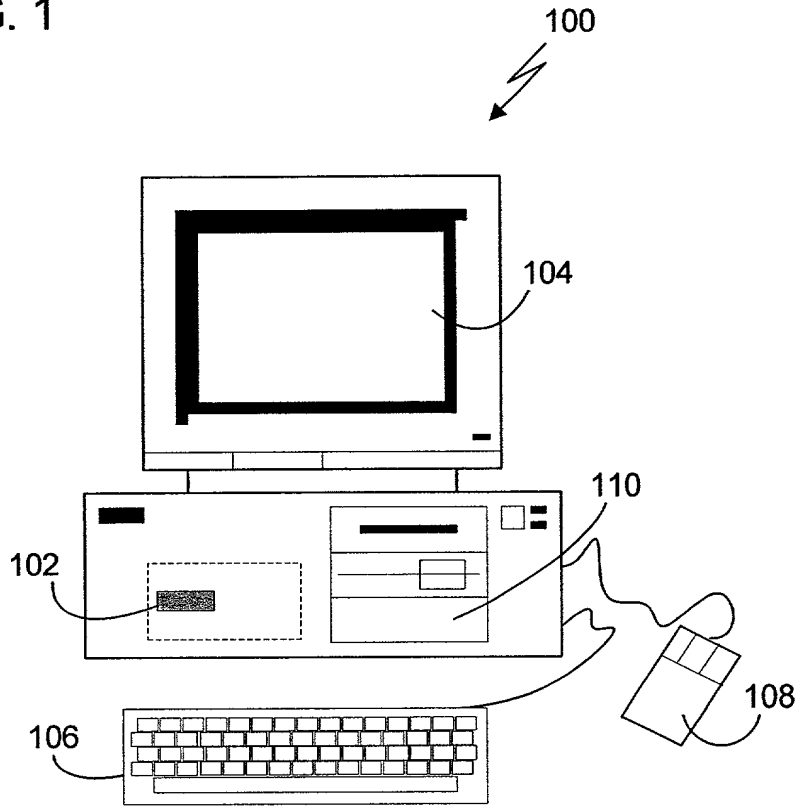
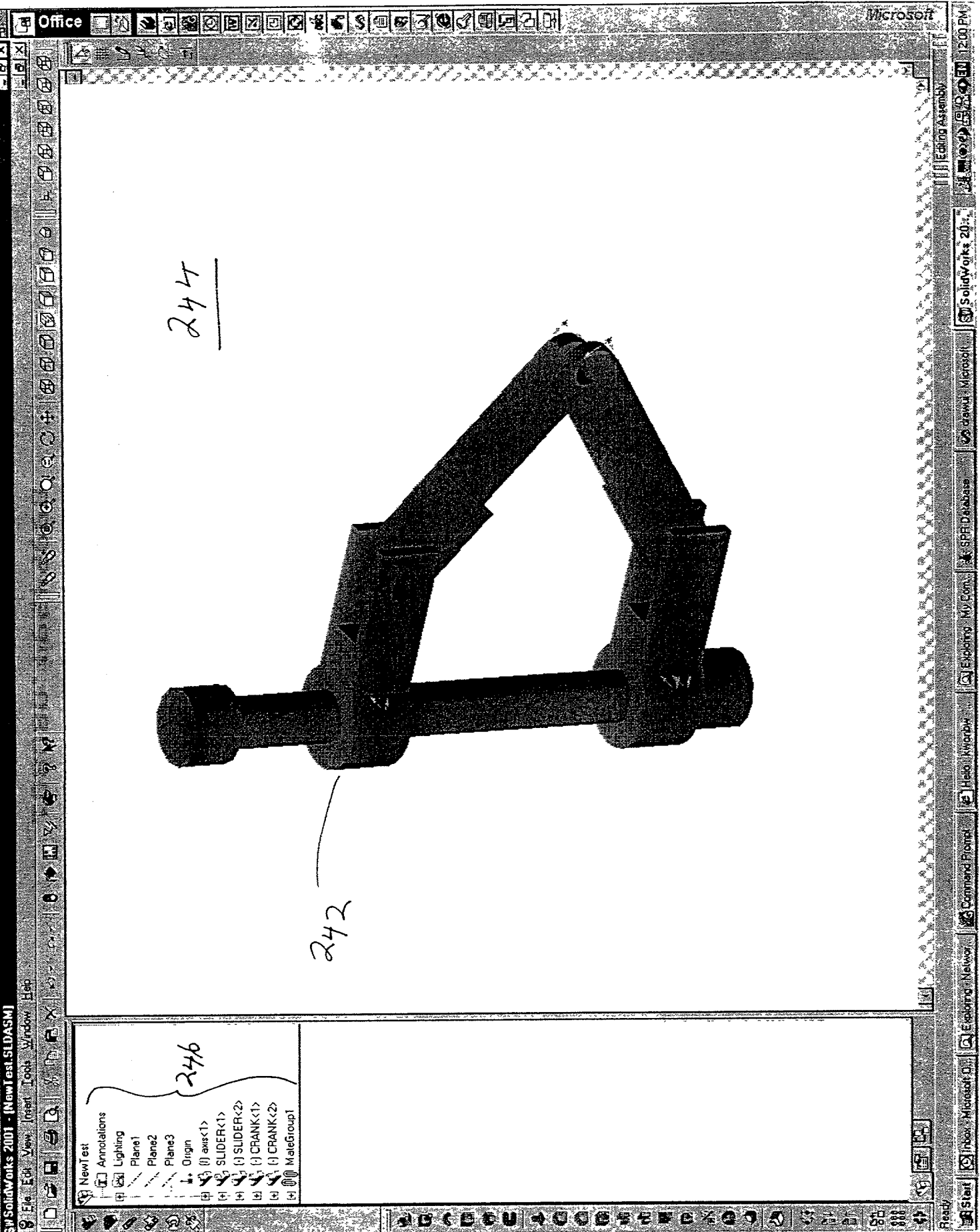

FIG. 1

119.0



244

242

246

- NewTest
- Annotations
- Lighting
- Plane1
- Plane2
- Plane3
- Origin
- (1) axis<1>
- (1) SLIDER<1>
- (1) SLIDER<2>
- (1) CRANK<1>
- (1) CRANK<2>
- MateGroup1

SW SolidWorks 2001 - [NewTest.SLDASM]

File Edit View Insert Tools Window Help

Microsoft

12:00 PM

Exploding Assembly

SolidWorks 2001

Microsoft

SPL Database

Exploding My Comp

Help: Assembly

Command Prompt

Exploding My Comp

Microsoft Office

Start

Ready

119.0

244

306

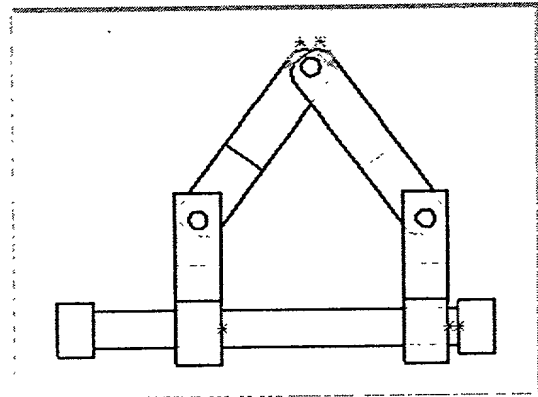

304

- New Test
- Annotations
- Sheet1
- Drawing View2
- Drawing View6

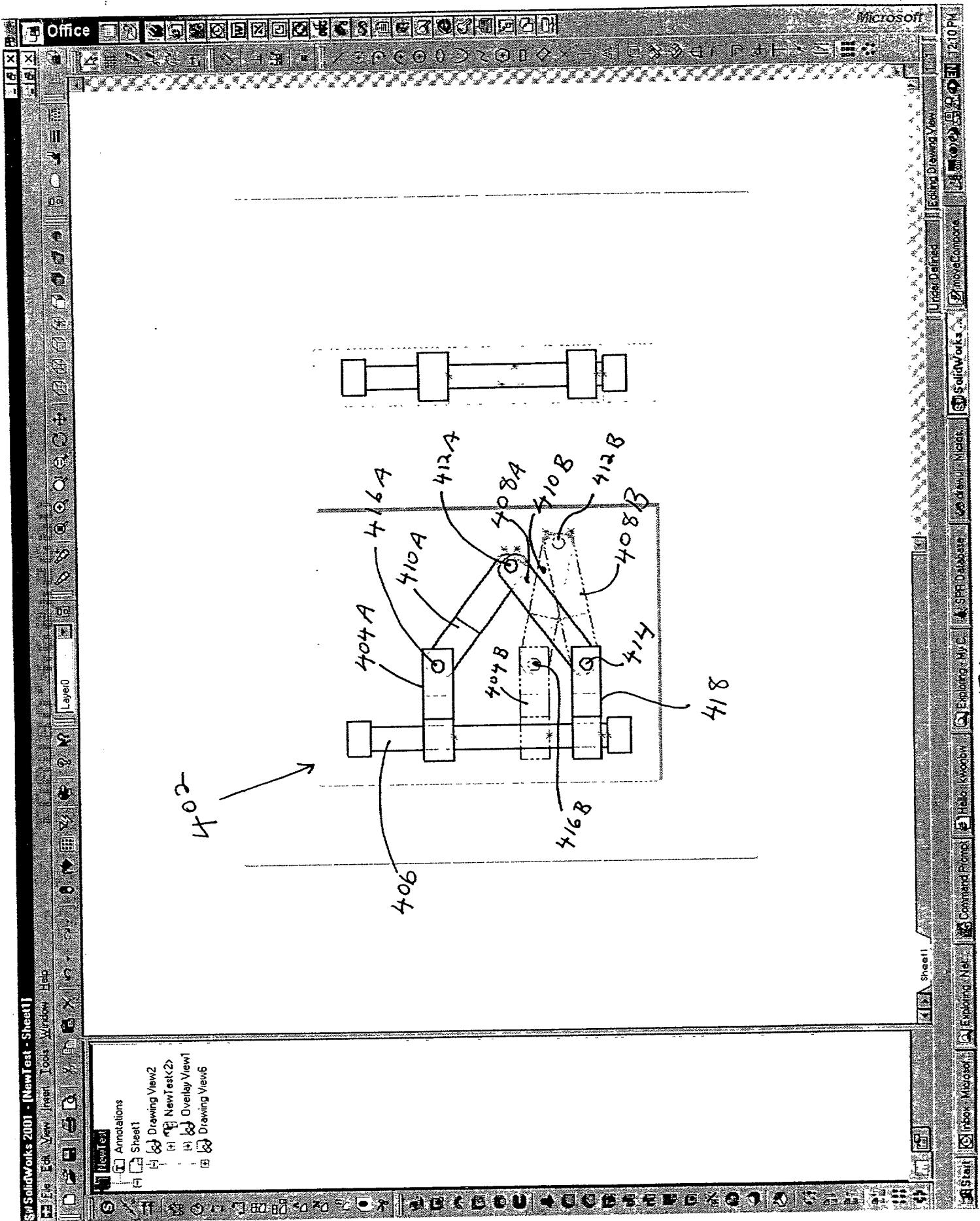

Fig. 4

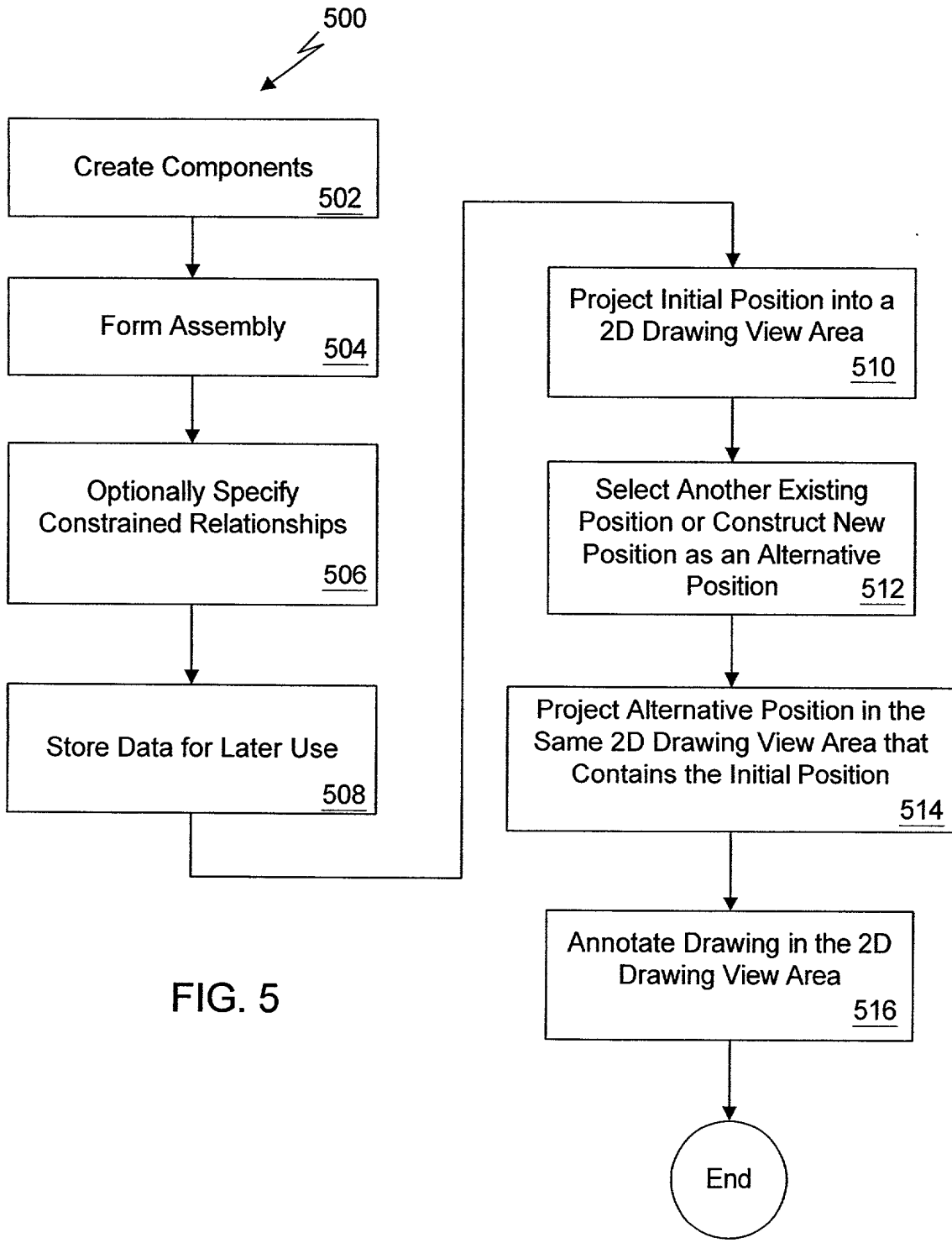

FIG. 5

600

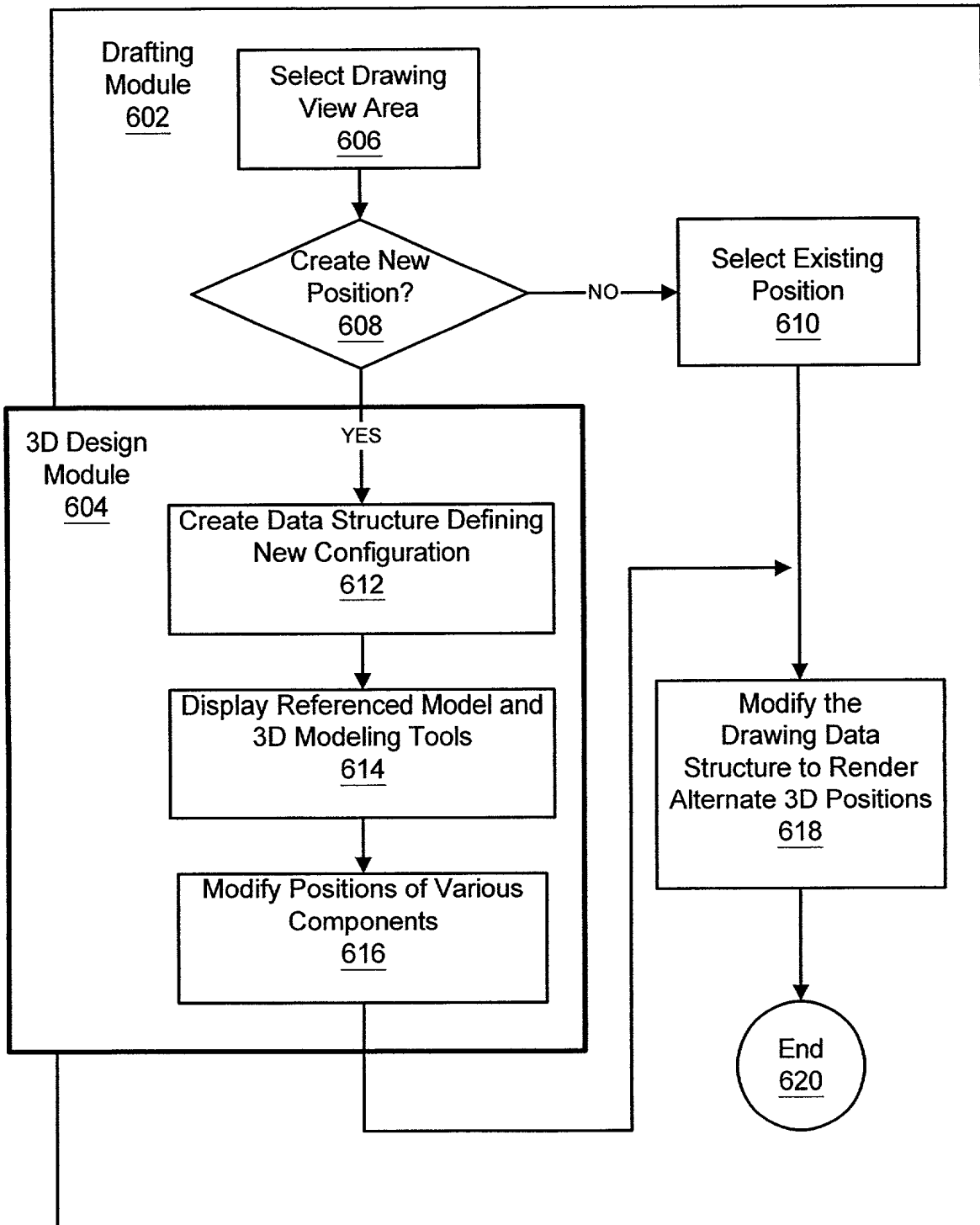

FIG. 6

702 Fig. 7

702

718

704

706

714

716

718

708

710

712

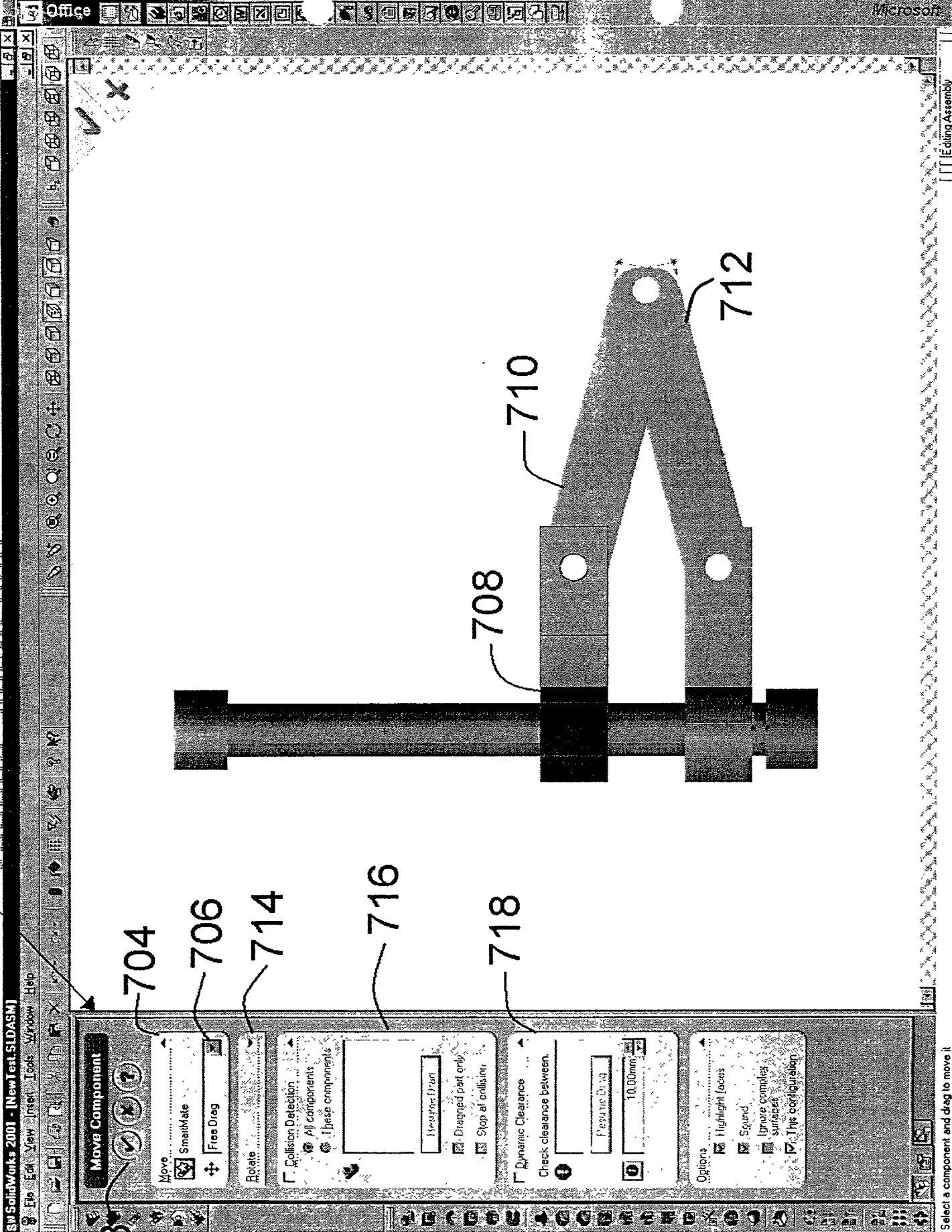

Select a component and drag to move it

FIG. 8

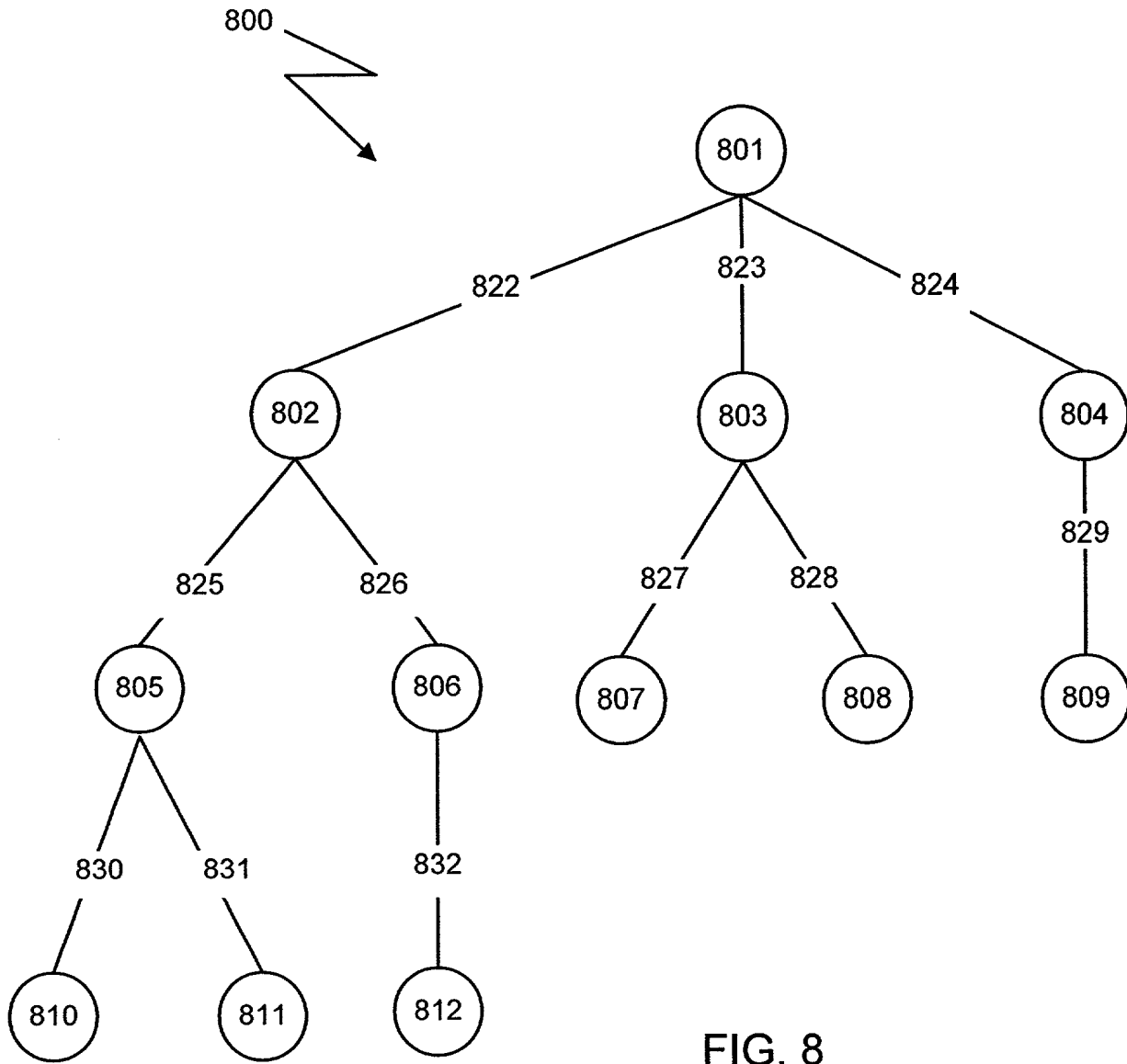

FIG. 8



FIG. 9

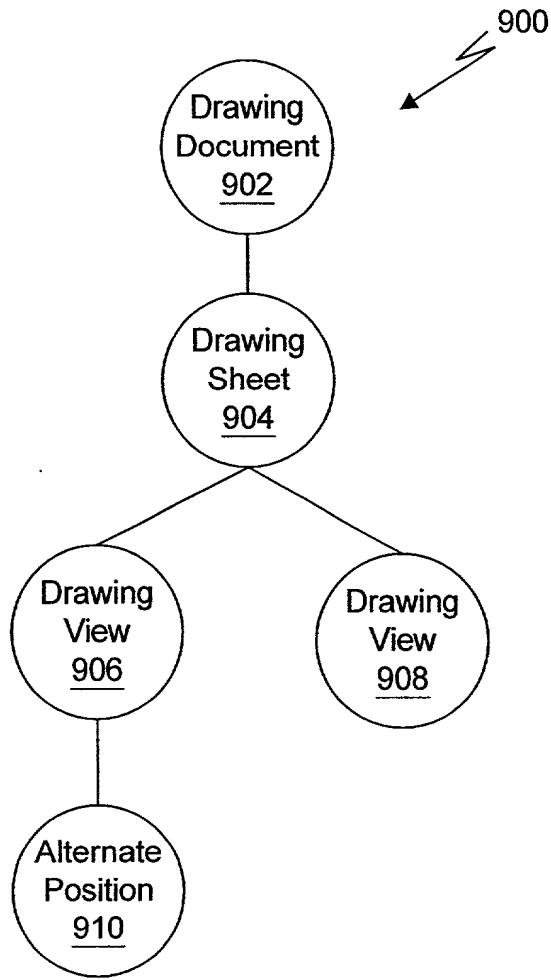

FIG. 9

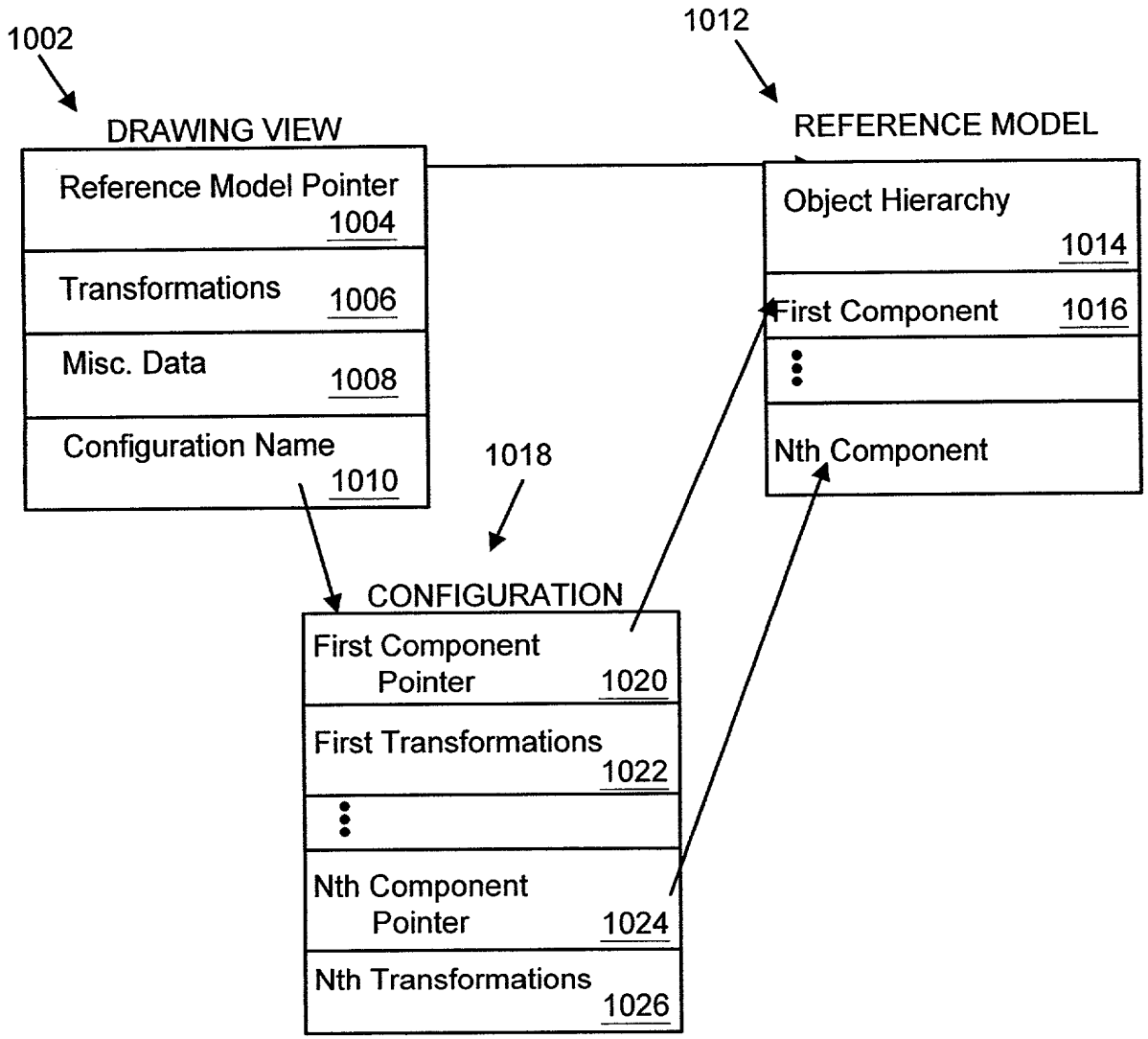

FIG. 10

FIG. 11

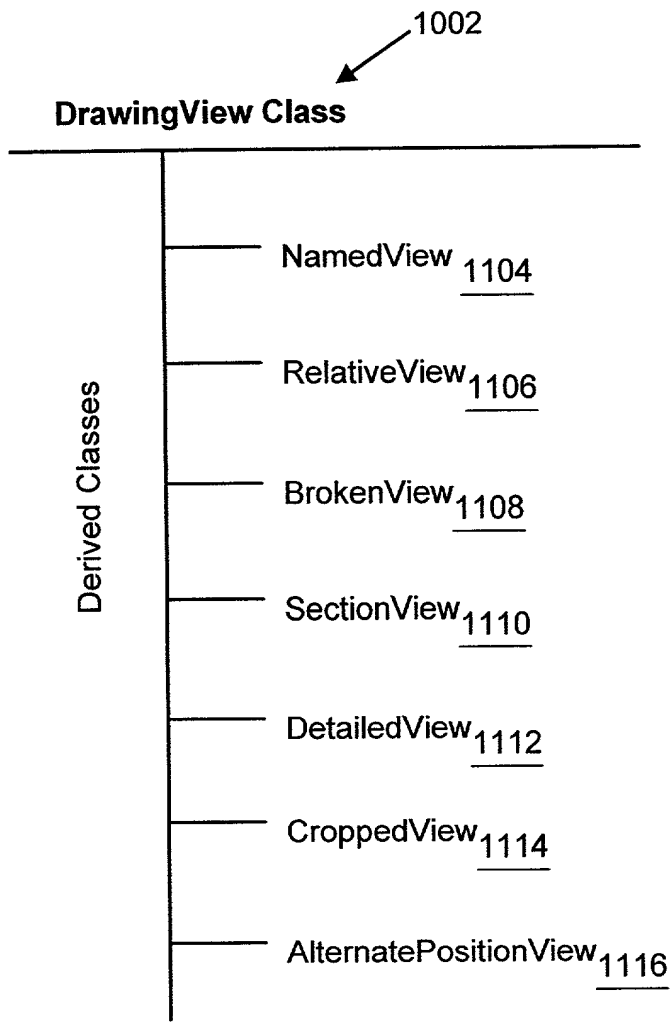

FIG. 11

1202 → T03000" 46212600

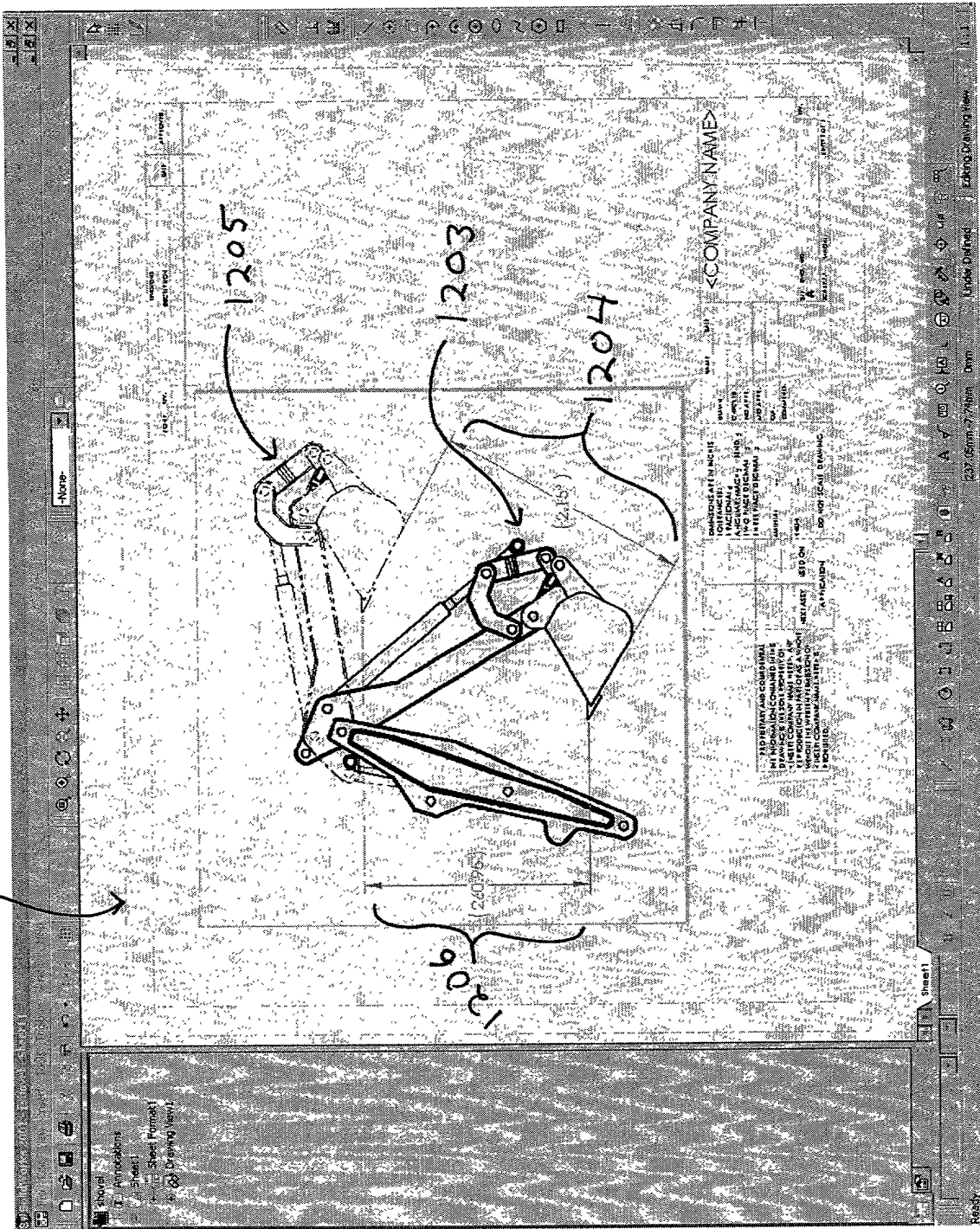

Fig. 12

1302

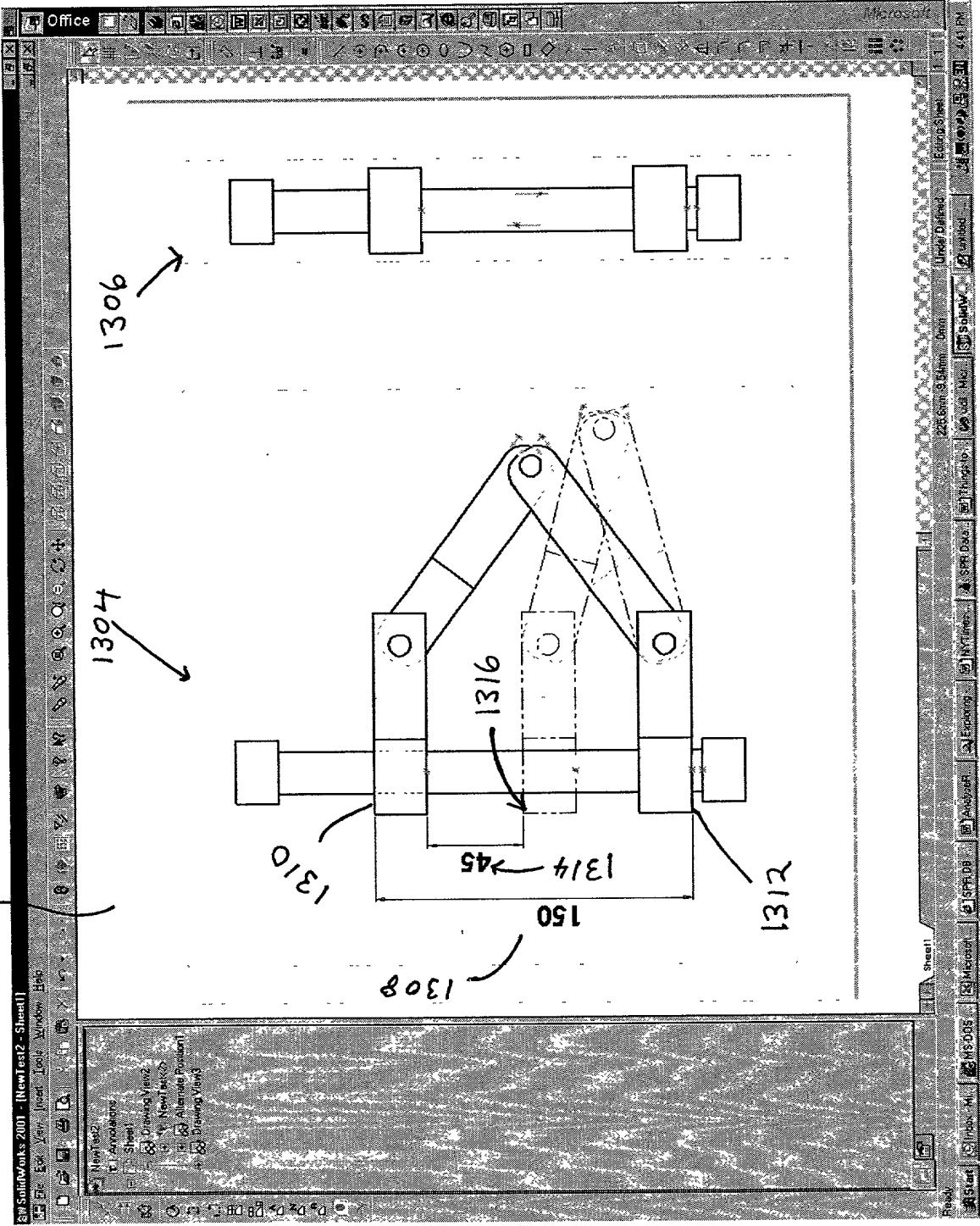

Fig. 13

FIG. 14

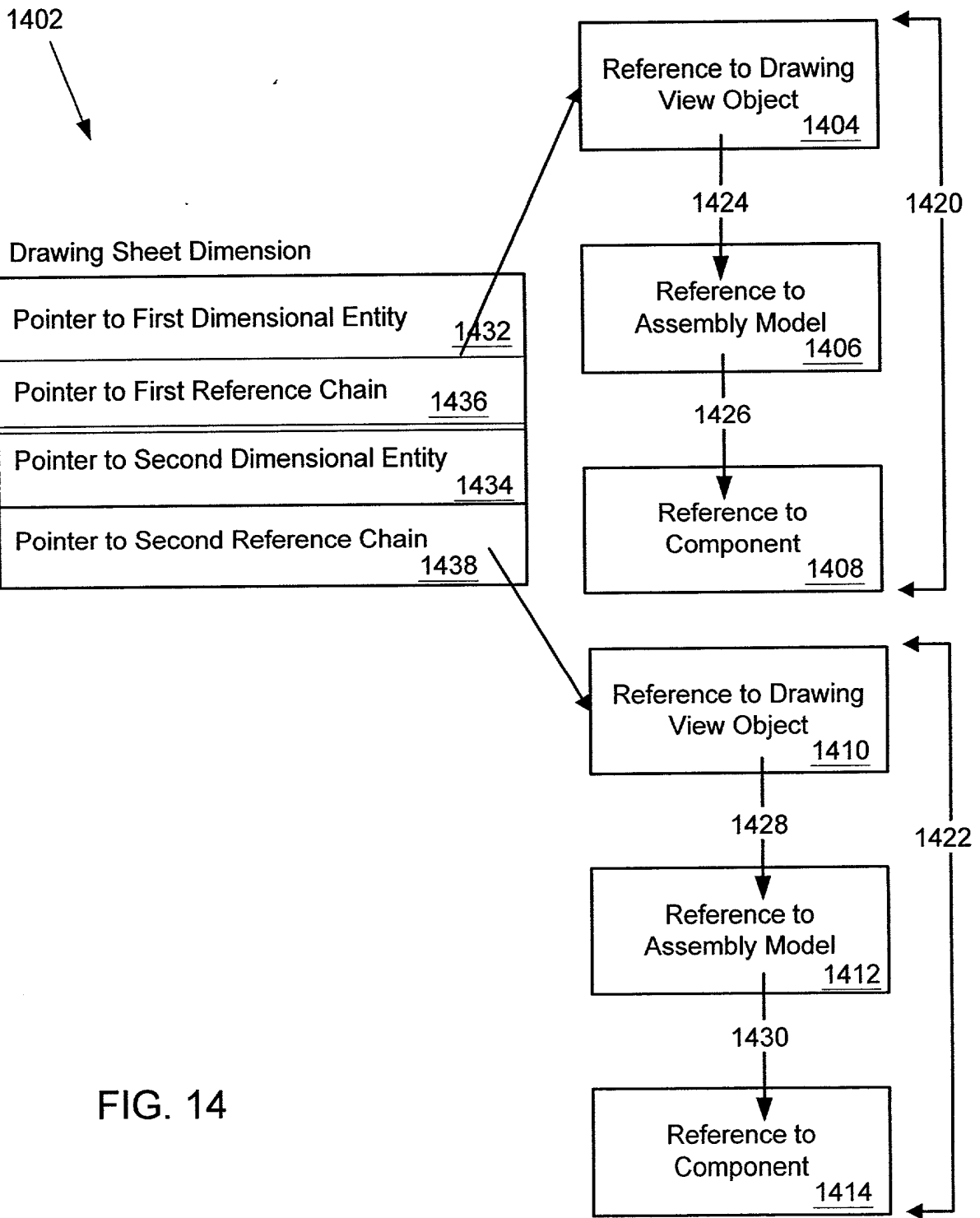

FIG. 14

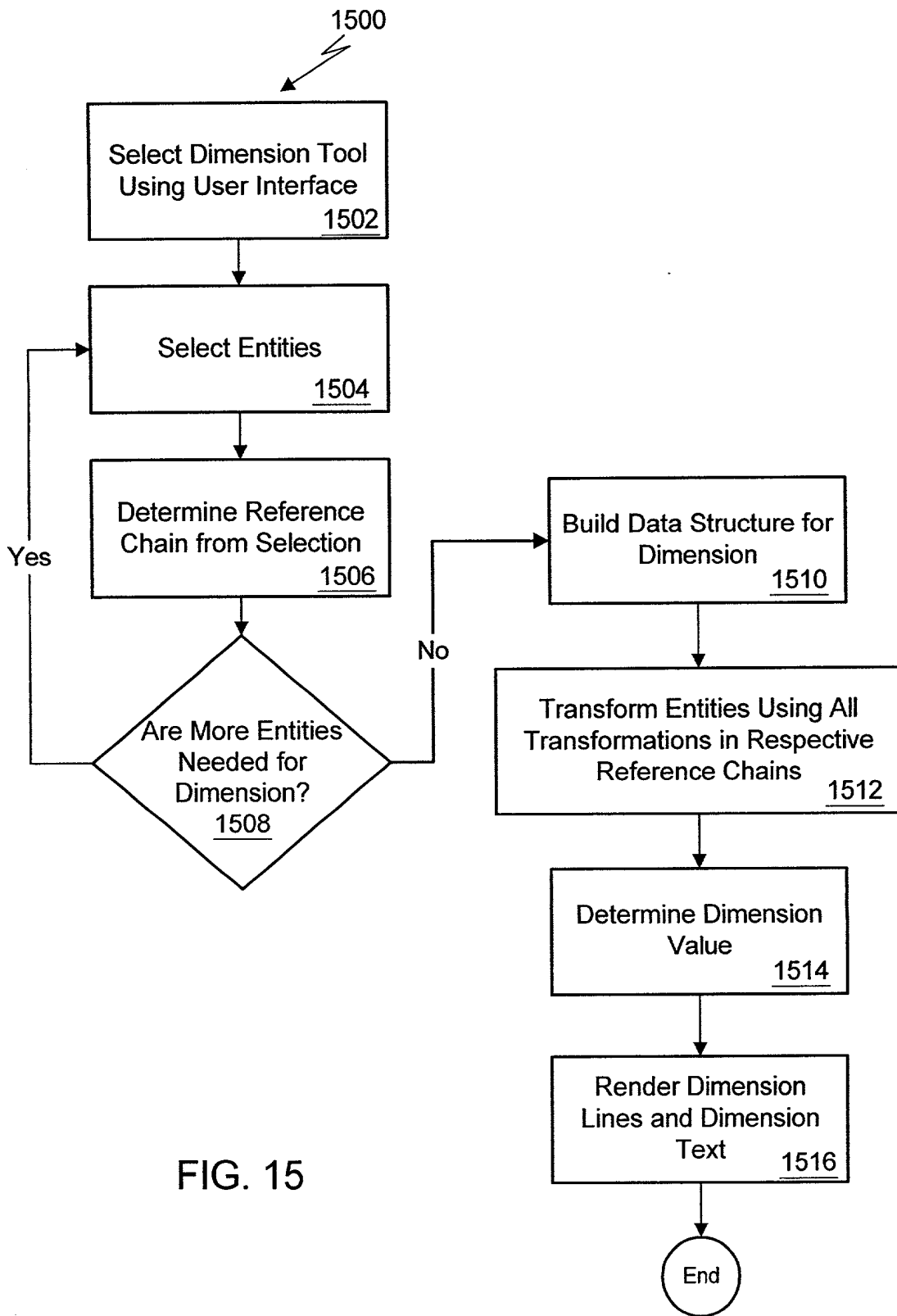

FIG. 15

FIG. 15